

TYPE: PROJECT: CATALOG#: **8" LED Disk Light with PIR Motion Sensor**





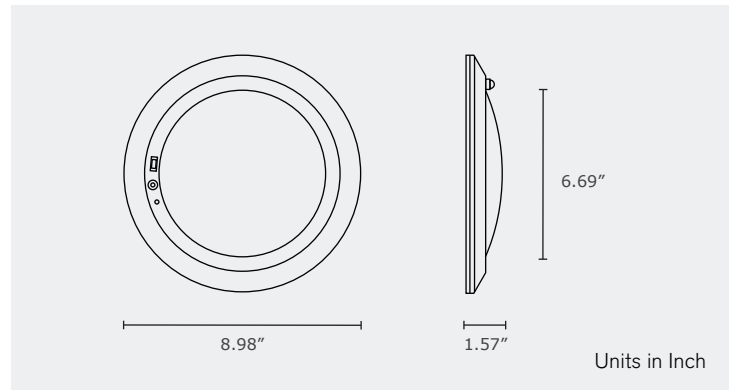

Product Features

- Made of durable aluminum body with PC diffuser, minimizing signal interference.
- Easy to install with keyholes for multiple ceiling box configurations
- With PIR motion sensor, it automatically turn on the light and off after 30 seconds.
- Die casting aluminum housing+plastic lens.
- Not dimmable.

Technical Drawing



Product Specifications

Model	Lumen Output	Wattage	Efficacy	Input Voltage	Colour Temperature	CRI	PFC	BEAM ANGLE	IP Rating
GN-PIR-8	1400 lm	20 W	70 W/lm	120V AC	3000K, 3500K, 4000K	Ra80	>0.90	120°	IP44

Order Form

GN - PIR-8 - 3 - 4 - 5 - 6

Series

3.WATTAGE	4.VOLTAGE	5.CCT	6. FINISH
20 20 W	A 120V AC	30 3000K 40 4000K	WH White
		35 3500k	

|TYPE:

|PROJECT:

|CATALOG#:

4" & 6" LED CLOSET LIGHT WITH PIR MOTION SENSOR

High Quality LED Chips
Brighter with Lower Consumption

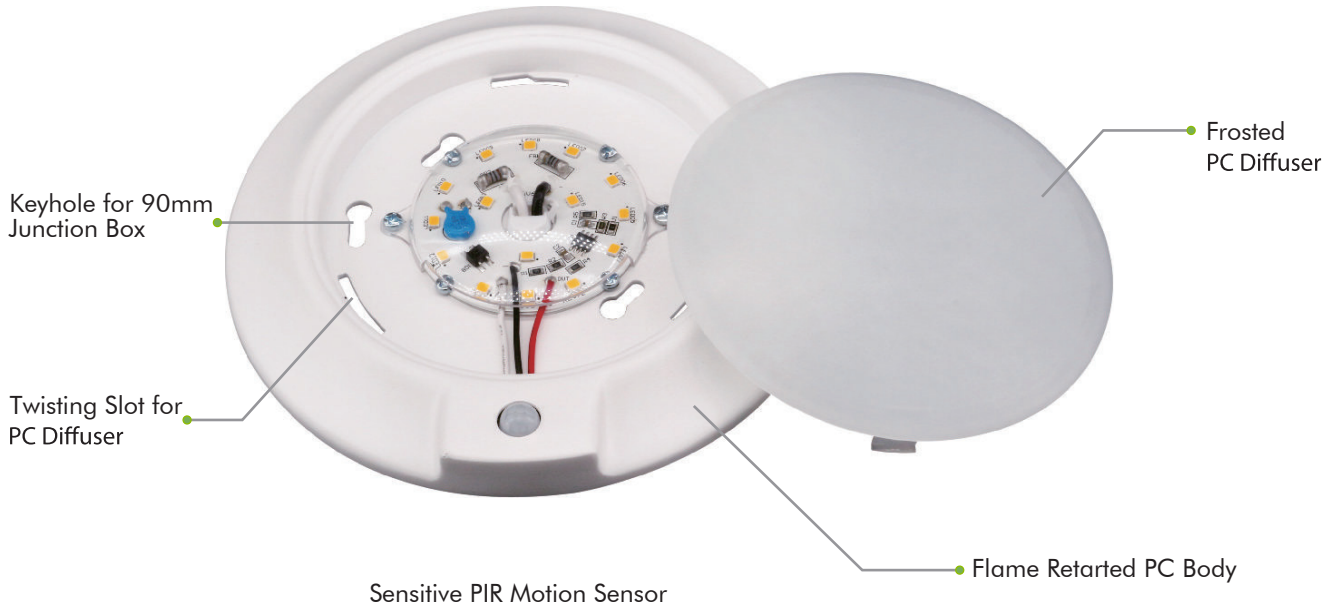

Effective Induction Area

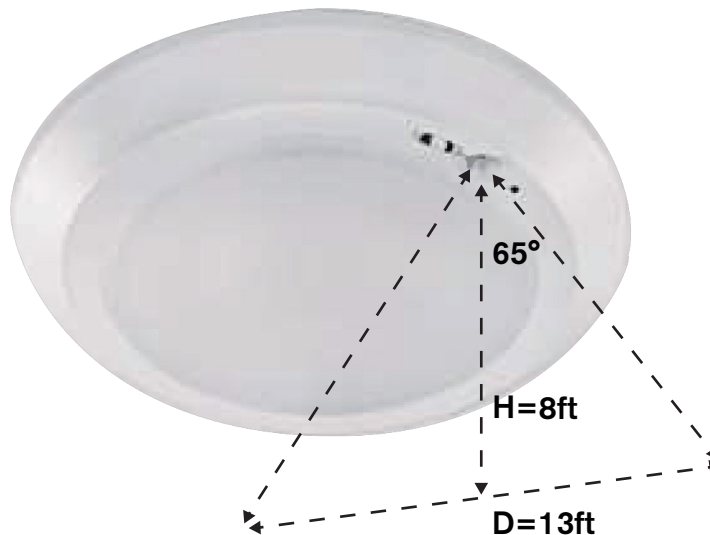

Light Mode

1. Daylight mode: Turns the light ON at the day and night time whenever motion is detected
2. Night mode: Turns the light ON when motion is detected and the space light intensity is <math>< 50\text{lux}</math>