

TYPE: PROJECT: CATALOG#: LED CEILING LIGHT

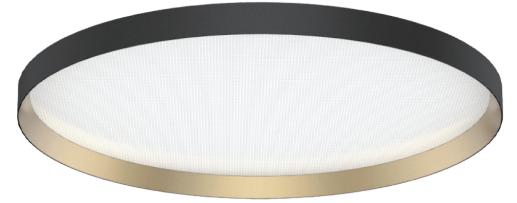

Product Features

GN-FL-T is a LED ceiling light which design with round aluminum housing with optimal cooling, microprismatic cover for eye comfort, RGBW function for decorative up light. This light available in 4 different mounting options.

Product Specifications

Model	GN-FL-T-450-18	GN-FL-T-450-26
Lumen Output	2200 lm	3000 lm
Power Consumption (W)	18 W	26 W
Efficacy	122 lm/W	115 lm/W
Input Voltage	120-277V AC	
Colour Temperature (CCT)	3000K, 3500K, 4000K	
CRI	Ra 80	
Dimensions	Ø 450 x 45 mm	
Beam Angle	90°	

Technical Drawing

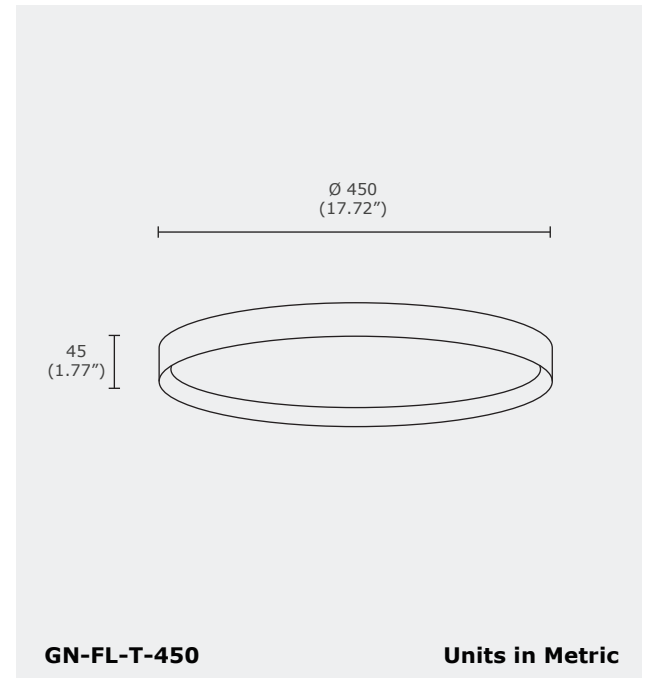

DIMMABLE   IESNA LM-79 IESNA LM-80 IP20 5 YEARS LIMITED WARRANTY INCLUDED

Order Form

GN	FL-T	450	4	5	6	7	8	9
Series	Model	Size						
4. WATTAGE	5. VOLTAGE	6. CCT	7. HOUSING	8. DIMMING	9. ACCESSORIES			
18 18 W	A 120-277V AC	30 3000K	BG Black & Gold	NN None	CS Cable Suspension			
26 26 W		35 3500K	WH White	DM 0-10V	RS Rod Suspension			
		40 4000K		TR TRIAC	SM Surface Mount			